

PARASOUND®

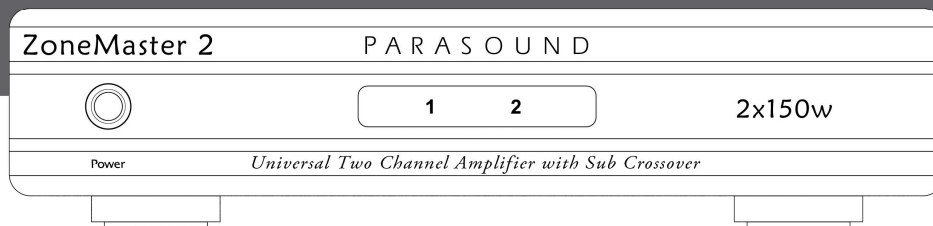

ZoneMaster 2

Universal Two Channel Amplifier with Sub Crossover

Owner's Manual



Important Safety Instructions

The lightning flash with the arrowhead symbol within an equilateral triangle is intended to alert the user to the presence of “dangerous voltage” inside the product that may constitute a risk of electric shock.

The exclamation point within an equilateral triangle is intended to alert the user to the presence of important operating and maintenance instructions in the literature accompanying the product.

TO REDUCE THE RISK OF ELECTRIC SHOCK, DO NOT REMOVE COVER. NO USER-SERVICEABLE PARTS INSIDE. REFER SERVICING TO QUALIFIED SERVICE PERSONNEL

1. **Read Instructions** — Read all the safety and operating instructions before operating this product.
2. **Retain Instructions** — Retain safety and operating instructions for future reference.
3. **Heed Warnings** — Adhere to all warnings on the product and in the operating instructions.
4. **Follow Instructions** — Follow all operating and use instructions.
5. **Cleaning** — Unplug this product from the wall outlet before cleaning. Use a damp cloth for cleaning. Clean the outside of the product only.
6. **Attachments** — Do not use attachments that are not recommended by the product manufacturer; they may be hazardous.
7. **Water and Moisture** — Do not use this product near water.
8. **Accessories** — Do not place this product on an unstable cart or stand. The product may fall, causing bodily injury and damage to the product. A product and cart combination should be moved with care. Quick stops, excessive force, and uneven surfaces may cause the product and cart to overturn.
9. **Ventilation** — Slots and openings in the cabinet are provided for ventilation to ensure reliable operation of the product and to protect it from overheating. These openings must not be blocked or covered. This product should not be placed in a built-in installation such as a bookcase or rack unless proper ventilation is provided.
10. **Power Sources** — Operate this product only from the type of power source indicated on the label. If you are not sure of the type of power supply to your home, consult your dealer or local power company. This product is equipped with a three-prong grounding plug. This plug will only fit into a grounding power outlet. If you are unable to insert the plug into the outlet, contact your electrician to replace your obsolete outlet. Do not defeat the safety purpose of the grounding plug.
11. **Power Cord Protection** — Power supply cords should be routed so that they are not likely to be walked on or pinched by items placed upon or against them.
12. **Lightning** — Unplug the unit from the wall outlet for added protection during a lightning storm and when it is left unattended and unused for long periods of time. This will prevent damage to the product due to lightning and power line surges.
13. **Overloading** — Do not overload wall outlets or extension cords. This can result in a fire or electric shock.
14. **Inserting Objects into Unit** — Never push objects of any kind into this product through any openings; they may touch dangerous voltage points or short out parts that could result in fire or electric shock.
15. **Servicing** — Do not attempt to repair or service this product yourself. Opening or removing covers may expose you to dangerous voltage and other hazards. Refer all servicing to qualified service personnel.
16. **Damage Requiring Service** — Unplug this product from the wall outlet and refer servicing to qualified service personnel under the following conditions: **a)** If the power-supply cord or plug is damaged. **b)** If liquid has been spilled into the product. **c)** If the product has been exposed to rain or water. **d)** If the product does not operate normally by following the operating instructions. **e)** If the product has been dropped or damaged in any way. **f)** If the product exhibits a distinct change in performance.
17. **Replacement Parts** — When replacement parts are required, be sure the service technician has used replacement parts specified by the manufacturer. Unauthorized substitutions may result in fire, electric shock, and other hazards.
18. **Safety Check** — Upon completion of any service or repairs to this product, ask the service technician to perform safety checks to determine that the product is in proper operating condition.
19. **Wall or Ceiling Mounting** — Mount the product to a wall or ceiling only as recommended.
20. **Heat** — The product should be situated away from heat sources such as radiators, heat registers, stoves, and other products (including amplifiers) that produce heat.

THE FOLLOWING PRECAUTIONS AND SAFETY INSTRUCTIONS ARE REQUIREMENTS OF UL AND CSA SAFETY REGULATIONS

Warning: To reduce the risk of fire or electric shock, do not expose this unit to rain or moisture.

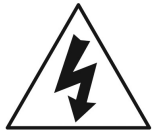

The graphic symbol of a lightning flash with an arrow point within a triangle signifies that there is dangerous voltage within the unit and it poses a hazard to anyone removing the cover to gain access to the interior of the unit. Only qualified service personnel should make any such attempt.



The graphic symbol of an exclamation point within an equilateral triangle warns a user of the device that it is necessary to refer to the instruction manual and its warnings for proper operation of the unit.

Do not place this unit on an unstable cart, stand, tripod, bracket, or table. The unit may fall, causing serious injury to a child or adult, and serious damage to the unit. Use only with a cart, stand, tripod, bracket, or table recommended by the manufacturer or sold with the unit. Any mounting of the device should follow the manufacturer's instructions, and should use a mounting accessory recommended by the manufacturer.

Read all the safety and operating instructions before connecting or using this unit.

Retain this notice and the owner's manual for future reference.

All warnings on the unit and in its operating instructions should be adhered to.

All operating and use instructions should be followed.

Do not use this unit near water. For example, near a bathtub, washbowl, kitchen sink, laundry tub, in a wet basement, or near a swimming pool.

The unit should be installed so that its location or position does not interfere with its proper ventilation. For example, it should not be situated on a bed, sofa, rug, or similar surface that may block the ventilation openings; or placed in a built-in installation, such as bookcase or cabinet, that may impede the flow of air through its ventilation openings.

The unit should be situated away from heat sources such as radiators, heat registers, stoves, or other devices (including amplifiers) that produce heat.

The unit should be connected to a power supply outlet only of the voltage and frequency marked on its rear panel.

The power supply cord should be routed so that it is not likely to be walked on or pinched, especially near the plug, convenience receptacles, or where the cord exits from the unit.

Clean unit only as recommended in its instruction manual.

The power supply cord of the unit should be unplugged from the wall outlet when it is to be unused for a long period of time.

Care should be taken so that objects do not fall, and liquids are not spilled, into the enclosure through any openings.

This unit should be serviced by qualified service personnel when:

- A. The power cord or the plug has been damaged; or
- B. Objects have fallen, or liquid has been spilled, into the unit; or
- C. The unit has been exposed to rain, or liquids of any kind; or
- D. The unit does not appear to operate normally, or exhibits a marked change in performance; or
- E. The device has been dropped, or the enclosure damaged.

**DO NOT ATTEMPT SERVICING OF THIS UNIT YOURSELF.
REFER SERVICING TO QUALIFIED SERVICE PERSONNEL.**

ATTENTION

POUR PREVENIR LES CHOCS ELECTRIQUES NE PAS UTILISER CETTE FICHE POLARISEE AVEC UN PROLONGATEUR, UNE PRISE CE COURANT OU UNE AUTRE SORTIE CE COURANT, SAUF SI LES LAMES PEUVENT ETRE INSEREES A FOND SANS EN LAISSER AUCUNE PARTIE A DECOUVERT.

CAUTION

TO PREVENT ELECTRIC SHOCK DO NOT USE THIS POLARIZED PLUG WITH AN EXTENSION CORD, RECEPTACLE OR OTHER OUTLET UNLESS THE BLADES CAN BE FULLY INSERTED TO PREVENT BLADE EXPOSURE.

CAUTION POWER LINES

Any outdoor antenna must be located away from all power lines.

OUTDOOR ANTENNA GROUNDING

If an outside antenna is connected to your tuner or tuner/preamplifier, be sure the antenna system is grounded so as to provide some protection against voltage surges and built-up static charges. Section 810 of the National Electrical Code, ANSI/NFPA No. 701984, provides information with respect to proper grounding of the mast and supporting structure, grounding of the lead-in wire to an antenna discharge unit, size of grounding conductors, location of antenna discharge unit, connection to grounding electrodes, and requirements for the grounding electrode.

- a. Use No.10 AWG (5.3 mm²) copper, No.8 AWG (8.4 mm²) aluminum, No.17 AWG (1.0 mm²) copper clad steel or bronze wire, or larger, as a ground wire.
- b. Secure antenna lead-in and ground wires to house with stand-off insulators spaced from 46 feet (1.221.83 m) apart.
- c. Mount antenna discharge unit as close as possible to where lead-in enters house.
- d. Use jumper wire not smaller than No.6 AWG (13.3 mm²) copper, or the equivalent, when a separate antenna grounding electrode is used. See NEC Section 810-21 (j).

EXAMPLE OF ANTENNA GROUNDING AS PER NATIONAL ELECTRICAL CODE INSTRUCTIONS CONTAINED IN ARTICLE 810. RADIO AND TELEVISION EQUIPMENT.

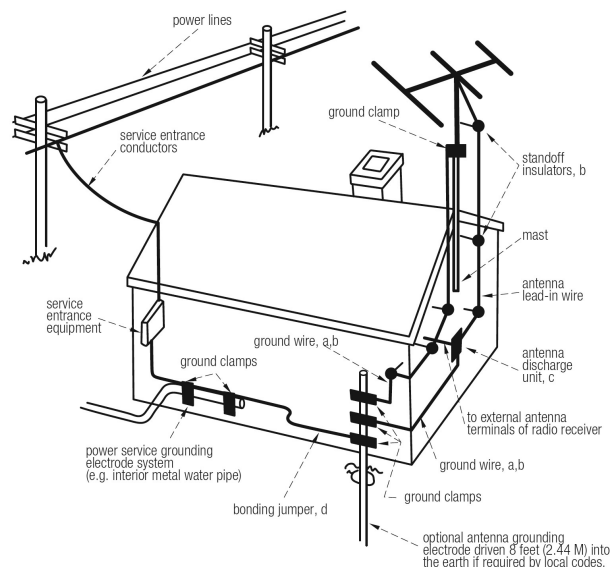

NOTE TO CATV SYSTEM INSTALLER

This reminder is provided to call the CATV system installer's attention to Article 82022 of the National Electrical Code that provides guidelines for proper grounding and, in particular, specifies that the cable ground shall be connected to the grounding system of the building, as close to the point of cable entry as practical.

INTRODUCTION

Congratulations on your purchase of this precision audio product and thank you for selecting Parasound. We are proud to offer you this versatile amplifier, knowing that it will bring you many years of enjoyment and dependable operation. Please take a few moments to read the following instructions so you can enjoy all the benefits of your new ZoneMaster 2's advanced performance capabilities.

You can find details of the ZoneMaster 2's specifications and advanced technology at www.parasound.com.

Enjoy.

The Parasound Staff

www.parasound.com

- ***Keep your Purchase Receipt/Dealer Invoice for future reference***
- ***Keep the carton in the event it is needed in the future***

Record the 5 digit serial number located on the bottom side of your ZoneMaster 2 in the space below. Also note your Parasound dealer's name and telephone number. Your purchase receipt-dealer invoice is required to determine if your ZoneMaster 2 is eligible for Parasound warranty service. We recommend that you make an extra copy of your original purchase receipt-dealer invoice and store it inside the ZoneMaster 2's carton. If the ZoneMaster 2 should require warranty repair you will need its original carton and foam packing inserts to ship it.

Please do not throw away the carton or foam packing inserts.

Parasound ZoneMaster 2 Serial # _____

Parasound Dealer: _____

Parasound Dealer Phone Number: _____

Date of Purchase: _____

Important Warranty information

There is no Parasound warranty for this unit if it was not purchased from an Authorized Parasound Dealer. Investigate warranty coverage statements made by *unauthorized* dealers very carefully, as Parasound will not provide service under our warranty and you will need to depend entirely upon the unauthorized dealer for warranty service. A list of Authorized Parasound Dealers and detailed warranty information is available at www.parasound.com or you can call Parasound at **(415) 397-7100** between 8:30 am and 4 pm Pacific time.

A missing or altered serial number could indicate that this unit was re-sold by an unauthorized dealer or is stolen merchandise. If this unit is missing its serial number or the serial number has been altered, you should return it to your dealer immediately for a full refund.

Table of Contents

<i>Introduction</i>	4
<i>Placement and Ventilation Guidelines</i>	6
<i>Audio Input Connections</i>	7
<i>Speaker Level Input Connector</i>	7
<i>Speaker Output Connections</i>	8
<i>Mono and Sub RCA Output Jacks</i>	8
<i>A and B Speaker Connections and Impedance</i>	8
<i>Crossover and Mode Switch</i>	9
<i>Channel Level Controls and Uses</i>	10
<i>Turn On Options (Audio Trigger or 12V Trigger)</i>	11
<i>Front Panel Power Buttons and Display</i>	12
<i>Frequently Asked Questions and Troubleshooting</i>	13
<i>If You Require Assistance or Warranty Repair</i>	14
<i>Specifications and Details</i>	15

Unpacking your ZoneMaster 2 & Placement Guidelines

Unpacking Your ZoneMaster 2

Carefully remove your ZoneMaster 2 from its shipping carton and locate its AC power cord and these included accessories:

- One 12V trigger wire with mono 3.5mm to 3.5mm mini plugs at both ends.
- Two different size screwdrivers, the larger one is for the speaker output connectors and the smaller one is for the speaker level input connector.
- 18AWG power cord

While you are unpacking your ZoneMaster 2, inspect it thoroughly for evidence of possible shipping damage and tell your Parasound dealer immediately if you find any. If possible, save and store both the inner and outer cartons and—most especially—the foam packing inserts, to protect the ZoneMaster 2 if you have to move it or ship it. This would be a good time to make a copy of your sales receipt for storage with the ZoneMaster 2's original packing. **Again: Do not throw away the carton or foam packing inserts.**

Placement Guidelines

Install your ZoneMaster 2 away from heat sources such as heating ducts, radiators, or other heat-producing components. Always position the ZoneMaster 2 horizontally. Observe the following ventilation guidelines when installing the ZoneMaster 2 in an equipment rack or any other enclosed space:

You should never install the ZoneMaster 2 in an unventilated equipment cabinet or compartment because hot air will not exhaust adequately to prevent overheating. Even a cabinet or enclosure whose front and back sides are open doesn't guarantee that air will circulate adequately pockets of intense heat can still develop around any heat-producing equipment. Allow a few inches of empty space on each side and above the unit and try to avoid crowding or stacking the ZoneMaster 2 tightly between other components. A ventilation fan is also recommended where other heat-producing equipment must be mounted close to the ZoneMaster 2.

! Safety Caution ! The ZoneMaster 2, as with any other high powered amplifier, could overheat if it is installed in a confined space without adequate ventilation. Continuous overheating can damage an amplifier and could ultimately pose a risk of fire.

If you are installing the ZoneMaster 2 yourself, use input and output cables that are long enough to leave at least two feet of slack; that will enable you to pull the ZoneMaster 2 out of a cabinet to check or to change connections without inadvertently disconnecting cables.

Rack Mounting Your Parasound ZoneMaster 2

A rack mount adapter is available for purchase separately (model ZRK). This kit allows two half sized ZoneMaster units or Z Custom units to be installed in a rack side by side. Included in the kit is also a panel extender to rack mount a single ZoneMaster 2.

AC Line Power Cord

Connect your sources and preamplifier before you plug in the AC cord. The power cord supplied with your ZoneMaster 2 is an IEC type 18AWG AC cord. The AC ground potential can vary between your AC outlets and the result can be an audible 60Hz (or 50Hz) hum heard in your speakers. To help avoid this problem plug your ZoneMaster 2 into the same AC wall outlet, power strip or line conditioner as all your other audio equipment.

Rear Panel Audio Connections

Always disconnect the AC cord to your ZoneMaster 2 before plugging in or unplugging any connections. Inserting or removing an interconnect cable's plug while this power amp is turned on can result in a burst of sound that can damage your loudspeakers. Make sure there is no strain or tension on any input cables, speaker wires, DC trigger wires or the AC cord that could cause them to pull loose.

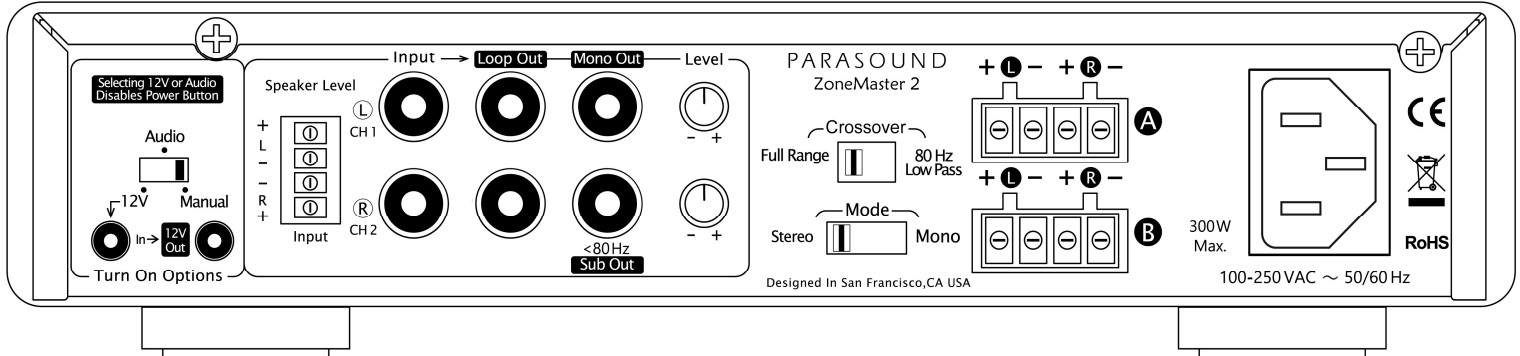

Audio Input Connections

The Speaker Level Input Connector

The speaker level input enables the ZoneMaster 2 to connect to any audio receiver or stereo system even if it lacks preamp output jacks. This is a high impedance input and the ZoneMaster 2's Speaker Level input can connect to the speaker terminals on any receiver or amplifier. This will not reduce the output power or degrade the sound quality of the speakers that are already connected directly to the "host" receiver or amplifier. Speaker level audio is converted to line level and routed to the Loop Out jacks which provide a line level output to drive additional amplifiers.

Polarity Is Important!

You must be careful to maintain polarity between the "host" receiver (or amplifier) and the ZoneMaster 2. Connect the + terminals of the receiver to the + terminals of the ZoneMaster 2's Speaker Level Input. Connect the - terminals of the receiver to the - terminals of the ZoneMaster 2's Speaker Level Input. If you do not maintain polarity then the Speaker Level Input will not function correctly and there could be no sound.

Note: You should connect only the RCA connections or the Speaker Level inputs, but not both or you could hear both sources at the same time.

Note: You can detach the speaker input connector block from the ZoneMaster 2 to make it easier to attach and secure the 4 speaker wires. It accepts bare wires up to AWG 16. Each wire should be twisted tightly and/or tinned with solder to prevent stray strands that could short circuit the amplifier. Since the Speaker Level input consumes a small fraction of a watt of your receiver's power output using large gauge speaker wire provides absolutely no performance advantage.

Line Input Jacks for Left and Right (channels 1 and 2)

These are standard line level audio Inputs for each channel. Connect these jacks to the Left and Right output jacks on your preamp, whole-house audio controller or the zone outputs of your AV receiver.

Audio Output Connections

Loop Out Jacks

These jacks enable the audio source to pass along or “daisy chain” to additional amplifier. Audio from the Speaker Level Input connector is also converted to line level and routed to the Loop Out jacks.

Mono Out Jack (Full range)

This is a full range output that combines the Left and Right channel inputs into a summed L + R mono signal. This could be useful for connecting a powered subwoofer that has its own built in crossover. It could also be used for connecting an additional amplifier in mono applications.

Sub Out Jack (80 Hz Low Pass)

This subwoofer output could be useful for connecting a passive in-wall subwoofer without the need for an external crossover. This output that combines the left and right inputs into a summed L + R mono signal. The low pass crossover is 80 Hz with an 18dB per octave slope. This jack is always active regardless of the setting of the Crossover switch or level controls. If you are using this output with a powered sub then you must turn off the crossover built into the sub.

Connecting Speaker Wires

Detach the green speaker output connecting blocks by pulling them away from the ZoneMaster 2 rear panel. This makes attaching speaker wires far more convenient. Connect the connecting block's + and – terminals to the corresponding + and – speaker wires. Never combine the – of two channels together. The ends of the wires should be twisted tightly and/or lightly tinned with solder to prevent stray wire strands from short circuiting the amplifier.

Speaker A and B Outputs

The ZoneMaster 2 is equipped with connections for two speakers on each channel (labeled A and B). This unique feature gives system designers greater flexibility and can usually avoid the added expense, complexity, heat and power consumption of additional amplifiers. The ability of the ZoneMaster 2 to drive two pair of speakers is credited to Parasound's 2 ohm stable high current design.

Typical applications for using both Speaker A and B outputs might include a large living room with four ceiling speakers. Another use for the B speakers could be in a subzone like a bathroom or hallway adjacent to the room where the A speakers are installed. This adjacent subzone might also use a passive in-wall volume control to adjust its listening level separately.

Total Speaker Impedance (A + B): The Right and Left channels are each capable of driving speaker loads as low as 2 ohms. An example of a 2 ohm load is one 4 ohm speaker connected to a channel's speaker output A while another 4 ohm speaker is connected to the same channel's speaker output B. When driving 2 ohm loads ensure the amplifier has adequate ventilation.

CONNECTION WARNING:

Never combine the Speaker L & R channel negative (-) outputs together.

Some speaker selectors combine the negative connections and are not compatible with the ZoneMaster 2. Combining the negatives of any two channels would cause the amplifier to engage its protection circuit and could seriously damage the amplifier. L and R channel speakers cannot be wired where they share a single negative (-) wire.

Crossover and Mode Switch

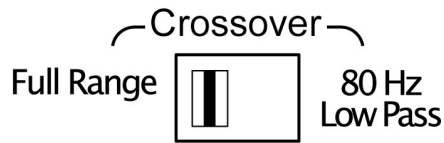

Crossover Switch (subwoofer mode)

The Crossover switch engages an 80Hz low pass filter (crossover). This allows one or more passive in-wall sub(s) to be powered by the ZoneMaster 2 without the need for an additional external crossover. You can connect one subwoofer to the left speaker outputs and a second subwoofer to the right speaker output. Both subwoofers will play the same mono signal. The RCA outputs are not affected by this switch. There are two positions for this switch:

Full Range: The speaker outputs will be full range without any filter. This is the normal setting when you are not powering a passive subwoofer.

80 Hz Low Pass: This setting will apply an 80Hz low pass filter (18dB/oct.) to the Left and Right speaker outputs. Select this option if you are using the amp to power passive subwoofer(s).

Mode Switch

The Mode switch determines if the amp will play in stereo or mono. The Mono Mode is particularly useful for applications such as bathrooms and hallways where mono speakers and a single speaker wire are more practical or could sound better. The RCA loop outputs are not affected by this switch.

Stereo: The Stereo setting routes the Left channel input to the Left channel speaker outputs and the Right channel input to the Right channel speaker outputs (A and B).

Mono: The Mono setting combines the Left and Right channel inputs into a summed L + R mono signal and routes it to both the Left and Right channel speaker outputs (A and B). In the Mono mode you can connect two mono speakers to the A output (one speaker connects to the L+ and L- and the other speaker connects to the R+ and R- terminals). An additional two mono speakers can be connected to the B output terminals. All speakers will play the same Mono signal.

Channel Level Controls

Each channel has its own Level control. Fully counter-clockwise is full attenuation and no sound will be heard from that channel. Fully clockwise is maximum volume. We made the Level control shafts very short so they are less likely to be turned unintentionally. When installed in a rack you may find it easier to use a Phillips head screwdriver to adjust the Level controls.

Additional Uses for the Level Controls:

Passive In-Wall Volume Controls

The Level controls are particularly useful when an in-wall passive volume control is used to adjust the listening level in a room or zone. By reducing the ZoneMaster 2's maximum output level you reduce the amount of power that is absorbed by the in-wall volume control. This prevents the volume control from overheating or even vibrating from the stress of absorbing extra amplifier power. It avoids wasting amplifier power and reduces distortion. For a room or zone with an in-wall volume control the correct way to optimize the settings for the Level controls and the in-wall volume control is this:

1. Music should be playing.
2. Turn the ZoneMaster 2's Level knobs for that room or zone fully counterclockwise to their minimum settings.
3. Turn the passive in-wall volume control knob fully clockwise to its maximum setting.
4. Slowly turn up the ZoneMaster 2's Level controls until the volume level in the room or zone is as high as you or the home owner might ever want it to be. This is the most appropriate setting for the Level controls because it will improve sound quality and prevent the home owner from over-driving the speakers.

Improving the Audio Trigger Turn On for Listening at Very Low Volume

You might prefer to listen to music in some zones at an extremely low volume level. The audio signal voltage at very low volume levels could fall below the ZoneMaster 2's threshold for the Audio trigger On-Off circuit to function and the zone will not remain on or it might continue to turn on and off every few minutes because the amp "thinks" there is no source playing. To overcome this, simply turn down **both** the L and R Level controls for that zone by the same amount. Setting the level controls to 12 o'clock is a good place to start. This way the Audio On-Off function will keep that zone powered on even for very low listening levels.

Limit Maximum Volume for a Room

By adjusting the channel level controls you can limit the maximum volume in a zone regardless of how high someone turns up the volume on the preamp or whole-house controller.

(See **Passive In-Wall Volume Controls** above)

Reducing Background Hiss

If you hear hiss or other background noise you can reduce its audibility by turning down the Level controls until you no longer hear the noise.

Balance Left and Right to Compensate for Room Placement

Adjust only the left or right channel Level knob until you hear your music equally from your preferred listening location.

Turn On Options

The setting of the rear panel Turn On Options switch determines how the amplifier turns on and off. Whenever the Turn On Options switch is set to 12V or Audio the ZoneMaster 2's front panel Power button will be disabled. There are three positions for this switch:

Manual

When the Turn On Options switch is in its Manual position the ZoneMaster 2 must be turned on and off manually by pressing the Power button on its front panel every time you wish to use your audio system.

Audio

When the Turn On Options switch is set to the Audio position, the ZoneMaster 2 will be turned on automatically when an audio signal is present at the L or R Input jacks. After the audio signal ceases the amplifier will remain on for about 6 minutes before shutting off. This prevents unintended turn-off during pauses in your music or movies. The audio sensing circuit functions the same way whether you are using the Line Input jacks or the Speaker Level Input.

Audio Trigger Sensitivity: The audio trigger in the ZoneMaster 2 is calibrated for turn on at a very low volume level (an audio signal as low as 2mV) and is not adjustable. If you need the amp to turn on at an extremely low volume level, simply turn down both Level control knobs. Start with the level controls at 12 o'clock and see if the volume level is low enough when the amp turns on.

12V Trigger In

When the Turn On Options switch is set to its 12V position, the ZoneMaster 2 is turned on and off only with an external +9 V to +12 V voltage from your preamp, AV Receiver or whole house controller. When the external voltage ceases the amp will turn off within a few seconds.

Note: Whenever the Turn On Options switch is set to 12V or Audio the ZoneMaster 2's front panel Power button will be disabled to prevent the amplifier from being turned on or off manually or by mistake.

Note: The 12V turn on trigger circuit in the ZoneMaster 2 requires a mere 5mA from the 12V trigger source.

12V Out Jack

The Trigger Out jack lets you loop or daisy chain the incoming trigger voltage to additional amplifiers or other components. This is an active output so even if you use the Audio or Manual turn on mode the 12V Out jack will supply 12 volts.

Whenever either the 12V or the Audio Turn On option is selected the front panel Power button will be disabled so that turn on and off is determined solely by the 12V trigger voltage from the preamp, receiver or by an active audio signal.

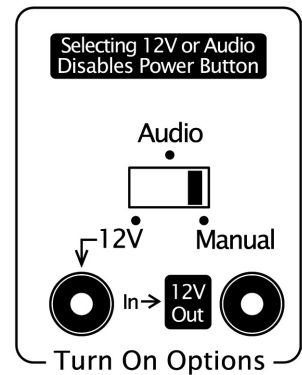

Front Panel Power Button and Display

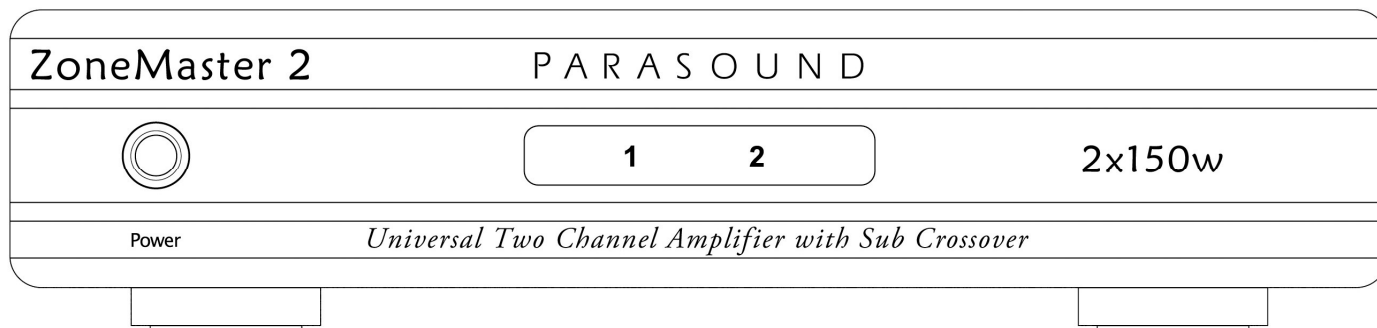

Power Button

If the Turn On Options switch is set to the Manual position, pushing the Power button turns the ZoneMaster 2 on. When turned on the ring around the Power button and the 2 channel status indicators will illuminate green. Pushing the Power button again turns the unit off. **If the rear panel Turn On Options switch is not set to “Manual” the front panel power button will not operate.**

Channel Indicators (1 and 2)

The channel numbers on the front panel illuminate according to each channel's operational status. Both channel indicators will always illuminate together. When the unit is turned on, both of the channel indicators will illuminate green.

Ch 1 = Left **Ch 2 = Right**

Green: Indicates normal operation.

Red: Indicates the protection circuit has suspended operation of both the Left (channel 1) and Right (channel 2) to protect the unit from an overload or because one or both of their speaker wires are short-circuited. The indicators might also alternate flashing green and red, depending on the musical content and volume levels. This also indicates a problem. Both channel number indicators will always illuminate the same color. Causes for the front panel indicators to illuminate red are:

- The speaker outputs for one or both channels are short-circuited (negative to positive) either at the amplifier, at the speaker or somewhere along the speaker wire.
- The negative speaker terminals have been combined (L- to R-).
- Too many speakers are connected and the combined impedance is below 2 ohms.
- The unit has overheated. Provide more ventilation or use a fan.
- The AC line voltage has exceeded the maximum allowed (132V when set for 115V or 264V when set for 230v, depending on your region's mains voltage).
- The amplifier has been damaged.

Checking for Short Circuits on the Speaker Outputs

If your ZoneMaster 2's front panel indicators are illuminated red or alternate illumination between green and red this indicates a problem. Your first step is to immediately turn off the amp. The most likely cause will be a short circuited speaker connection. To check for this type of fault temporarily unplug both of the green speaker output connecting blocks. Now turn the amp back on and play music. If the front panel lights now illuminate green then you've eliminated the amp as the source of the problem. Please check your speaker wires and attached speakers for short circuits or impedance below 2 ohms.

Frequently Asked Questions

The unit will not turn on

- Check the setting of the Turn On Options switch (The front panel Power button will be disabled if the switch is set to Audio or 12V).
- Check that the AC power is live. When the AC power is live and the unit is turned off, the Power button will illuminate red.

When using the audio trigger the amp is turning off during quiet listening

- Turn down both Level controls (12 O'clock is a good place to start).
- See page 10 for more details.

When using the audio trigger the amp never turns off

- The audio trigger circuit waits for up to 10 minutes before shutting the amp off. Try waiting at least 10 minutes after stopping the audio source.
- Ensure that the Turn On Option switch is set to the "Audio" position.
- If the amp still will not turn off then you may have too much noise (hiss or hum) in the audio signal path. You must eliminate the source or cause of this noise. If you are unable to do this you will have to resort to using the 12V triggers.

Front panel channel indicators are red or flashing green and red

- Check speakers and speaker wires for short circuits.
- Ensure that you have not combined the negative (-) terminals of any of the speaker outputs.
- You may have attached a total speaker load that is below the 2 ohm minimum. The total speaker load for that channel is the combined parallel impedance of one channel. If two 8 ohm speakers are attached the channel "sees" only 4 ohms. If two 4 ohm speakers are attached the channel "sees" only 2 ohms.
- The amp may have overheated and will not resume operation until it cools down. Ensure that you have provided adequate ventilation especially when driving low impedance loads.
- See page 13 for more details.

Why is there no sound when using the Speaker Level Input?

- Ensure that you have connected the correct polarity at both ends of the speaker wire.
- Try reversing the polarity at one end of the speaker wire.

Why is there little sound or only very low frequencies heard from the sub?

- If you are using the Sub RCA output to a powered sub, make sure the crossover built into your powered sub is turned off (or use the Mono full range RCA output).

I can hear a hum or buzzing noise from my speakers

- Cable TV is the most common source of hum or buzzing noise in a system. If you have a cable TV box connected to your audio system temporarily remove the incoming cable signal from the Cable TV box. If the hum goes away the problem is with the cable TV ground. You will need a cable TV ground Loop Isolator which is an inexpensive device that attaches between your incoming cable and the Cable TV box.
- Light dimmers can cause noise in your audio. Try turning lights that are controlled by dimmers all the way off. If the hum goes away the problem is electrical noise the dimmers introduce into your home's AC power.
- Ground loops are also a common cause of hum and buzzing noise. Finding a ground loop is a process of elimination. Unplug your source components one at a time. When the hum goes away you've identified the source of the ground loop. You might be able to stop the hum by attaching a wire from the chassis of the offending component to the chassis or ground screw of your preamplifier.

Maintaining Your ZoneMaster 2

Your ZoneMaster 2 requires no periodic maintenance and has no user serviceable parts inside. To avoid risk of electric shock do not remove the top cover. To keep it clean use only a soft cloth moistened with a few drops of clear water or window cleaner. Never use any solvents or abrasives.

Are You Having Difficulty?

Warranty Repair

Call your Parasound dealer first. If the dealer can't help you with your problem we encourage you to call Parasound's Technical Service Department at **415-397-7100**, Monday - Friday, 8am - 4pm Pacific time. We can suggest other diagnostic tests you can easily perform.

If we determine that your ZoneMaster 2 should be returned to Parasound or an Authorized Parasound Warranty Center for inspection and possible servicing, we will provide the location of a warranty center near you or shipping instructions for the unit's return to Parasound.

Read your accompanying Parasound Limited Warranty carefully to understand the applicable rights and limitations. This section provides instructions for obtaining repairs, both for units covered under the Parasound Limited Warranty and for units or situations which are outside the Warranty.

Unit is not eligible for repair under the terms of the Parasound warranty if:

1. Unit was not purchased from a Parasound Authorized Dealer.
2. You do not have the original bill of sale or sales receipt from a Parasound Authorized Dealer.
3. You are not the original owner. The Parasound warranty is not transferable.
4. Unit's serial number was removed, modified, or defaced.
5. Unit shows evidence of abuse and/or misuse.
6. Unit was modified in any way.
7. A prior repair was attempted by an unauthorized repair station.

Before You Return Any Unit to Parasound for Service

Before you send your unit to Parasound, you will need to obtain a specific Return Authorization (RA) number and shipping instructions from Parasound's Technical Department. The RA number must be clearly marked on the outer carton. Use the original factory packing materials and arrange adequate insurance to cover its replacement value. You must include a copy of your purchase receipt, since this document establishes the validity of this unit's warranty. Warranty repairs are only performed by Parasound or Parasound Authorized warranty centers when your purchase receipt is from a Parasound Authorized Dealer or Parasound Authorized Reseller.

Do not ship to Parasound by the USPS (US Postal Service) - we will not accept delivery. We will also refuse delivery of units whose cartons show evidence of damage caused by inadequate packing.

Specifications and Details

Power Output – RMS, Both Channels Driven (20Hz - 20kHz)

120 watts x 2 @ 8Ω

150 watts x 2 @ 4Ω or 2Ω

Minimum Speaker Impedance:

A+B Outputs of a Single Channel: 2 Ω

Note: Continuous operation at this minimum impedance might require additional ventilation for the amplifier.

Frequency Response:

20 Hz - 20 kHz, +0/-0.25 dB

5 Hz - 50 kHz, +0/-3 dB

Total Harmonic Distortion:

< 0.05 % at typical listening levels

< 1.0% at full power

Interchannel Crosstalk: 70 dB at 20 kHz

Total Gain: 29 dB (Level controls set to Maximum)

S/N Ratio: >112 dB, input shorted, IHF A-weighted

DC Trigger Requirements: +9 Vdc to +12 Vdc, 5 mA

Audio Trigger Requirements: 2 mV audio signal

Low Pass Crossover: 80Hz, 18dB per octave

AC Power Requirement:

300 Watts maximum

30 Watts typical (music playing)

15 Watts idle (no music playing)

0.5 Watts in standby

100-250 VAC 50/60 Hz (automatic)

Dimensions:

Width: 8.5" (220 mm)

Depth: 10" (254 mm)

Depth: 12" (305 mm) with AC cord and cables connected

Height, with feet: 2" (51 mm)

Height, without feet: 1.75" (45 mm), 1U

Weight:

Net: 4.3 lbs. (2.0kg)

Shipping: 7.3 lbs. (3.3 kg)

Specifications and features subject to change or improvement without notice.

Rev 1.0, Copyright 2020

We invite you to visit www.parasound.com for the most up-to-date information on your unit and to find out about other Parasound products. Learn why Parasound has been a quality and value favorite of magazine reviewers, sound professionals and listeners like you since we were founded in 1981.

PARASOUND
NEW CLASSIC

HALO
by
PARASOUND

Z CUSTOM
PARASOUND



PARASOUND®

Parasound Products, Inc. 2250 McKinnon Ave, San Francisco, CA 94124

Customer Service: 415-397-7100

www.parasound.com